

PRODUCT CODE: SR20B
EXTENSION RING

DESCRIPTION

20mm Extension Ring

FINISH

Black Enamel

MATERIAL

Steel

PACKAGING

Packed in qty 20

ADDITIONAL NOTES

Conforms to BS EN61386-1

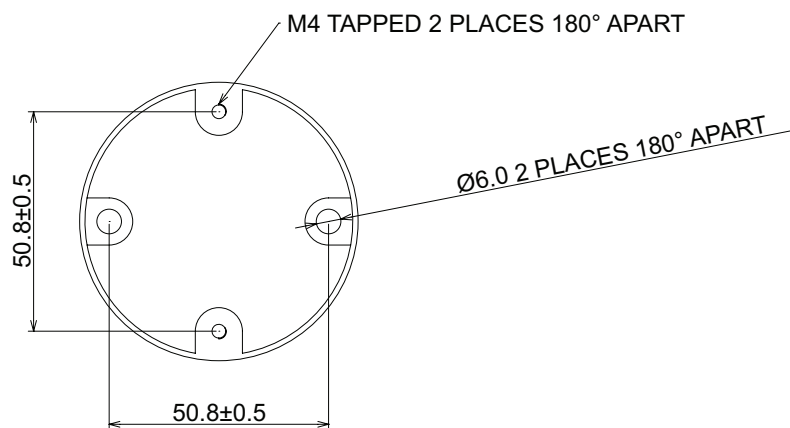
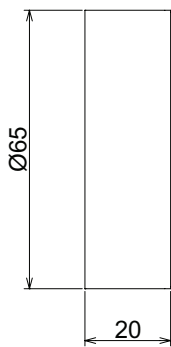
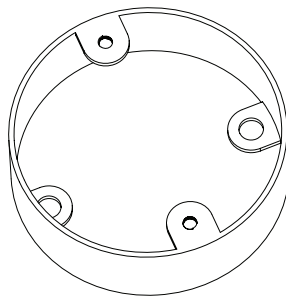

 Values are nominal and with a general tolerance $\pm 5\%$ unless otherwise specified